

Stacking high flow valves with air pilot or solenoid actuation. Lightweight plastic bodies feature push-in or threaded connections. Stacking valves feature modular inlet and exhaust facility.



- High flow, compact size
- Push-in or threaded connection
- DIN rail or block mounting
- Light weight construction



**For ATEX specific products
contact Sales Office**

Operating information



Working pressure;
 Pneumatically operated: 2-10 bar
 Electrically operated, bistable: 2-10 bar
 Electrically operated, monostable: 3-10 bar
 Working temperature -15 °C to +60 °C

	PVL-B	PVL-C
Flow (Qmax):	900 l/min	1800 l/min
Flow Qn:	540 l/min	1100 l/min



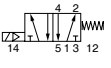
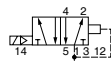
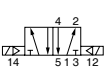
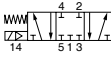

Flow measured with valve stacked in island.

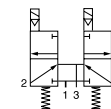
PVL-B & PVL-C Valve body - Stand alone and stackable design - Without pilot

Pneumatic or 15 mm electric pilot must be ordered separately

Symbol	Description	Valve size	Connection	Weight (g)	Stand Alone	Stackable
					Order code	Order code
	5/2 single acting / Spring return	PVL-B	Push-in Ø 6 mm	125	PVL-B111606	PVL-B121606
			G 1/8	125	PVL-B111618	PVL-B121618
		PVL-C	Push-in Ø 8 mm	240	PVL-C111608	PVL-C121608
			G 1/4	240	PVL-C111619	PVL-C121619
	5/2 single acting / Air spring return	PVL-B	Push-in Ø 6 mm	125	PVL-B113606	PVL-B123606
			G 1/8	125	PVL-B113618	PVL-B123618
		PVL-C	Push-in Ø 8 mm	240	PVL-C113608	PVL-C123608
			G 1/4	240	PVL-C113619	PVL-C123619
	5/2 double acting	PVL-B	Push-in Ø 6 mm	120	PVL-B112606	PVL-B122606
			G 1/8	120	PVL-B112618	PVL-B122618
		PVL-C	Push-in Ø 8 mm	230	PVL-C112608	PVL-C122608
			G 1/4	230	PVL-C112619	PVL-C122619
	5/3 APB (All Ports Blocked)	PVL-B	Push-in Ø 6 mm	130	PVL-B117606	PVL-B127606
			G 1/8	130	PVL-B117618	PVL-B127618
		PVL-C	Push-in Ø 8 mm	250	PVL-C117608	PVL-C127608
			G 1/4	250	PVL-C117619	PVL-C127619
	5/3 Vented centre	PVL-B	Push-in Ø 6 mm	130	PVL-B118606	PVL-B128606
			G 1/8	130	PVL-B118618	PVL-B128618
		PVL-C	Push-in Ø 8 mm	250	PVL-C118608	PVL-C128608
			G 1/4	250	PVL-C118619	PVL-C128619
	Double 3/2 Normally Closed (NC)	PVL-B	Push-in Ø 6 mm	130	PVL-B115606	PVL-B125606
			G 1/8	130	PVL-B115618	PVL-B125618

Head and tail sets and intermediate supply modules

	Type of mounting	Description	Valve size	Port size	Weight (g)	Order code
	On DIN rail	Single air supply head and tail set	PVL-B	G1/4	175	PVL-B1719
			PVL-C	G3/8	195	PVL-C1713
		Dual air supply head and tail set	PVL-B	G1/4	245	PVL-B1729
			PVL-C	G3/8	285	PVL-C1723
	Surface	Single air supply head and tail set	PVL-B	G1/8	200	PVL-B1818
			PVL-C	G1/4	225	PVL-C1819
		Dual air supply head and tail set	PVL-B	G1/8	260	PVL-B1828
			PVL-C	G1/4	280	PVL-C1829
	On DIN rail	Intermediate supply module	PVL-B	G1/8	150	PVU-LBB118
			PVL-C	G1/4	200	PVU-LCC119
	On DIN rail	Kit for stacking PVL-B & PVL-C	PVL-C/B	G1/4-G1/8	640	PVU-LCB119
		Including :				
		- 1 transfert / take-off module				
		- 1 PVL-C head module				
		- 1 PVL-B end plate				







Air-pilot actuator for PVL-B and PVL-C valve

For use with PVL-B and PVL-C valve body

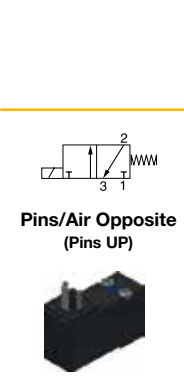
	Description	Pneumatic connection	Weight (g)	Order code
	Air-pilot actuator for PVL-B & PVL-C 15mm solenoid body	Push-in Ø 4 mm	7	PVA-P111
		Threaded M5	2	PVA-P115



15mm DIN Form C (8mm spacing) pilot solenoid valve

For use with PVL-B and PVL-C valve body

	Manual Overrides		Flush (Not Extended)			Extended	
		Without Manual Override	Blue Override, non locking	Yellow Override, Locking	Blue Override, non locking	Yellow Override, Locking	
	Voltage	W (g)	Order code	Order code	Order code	Order code	Order code
	12 Vdc	38	 P2E-KV32B0	P2E-KV32B1	P2E-KV32B2	P2E-KV32B3	P2E-KV32B4
	24 Vdc	38	 P2E-KV32C0	P2E-KV32C1	P2E-KV32C2	P2E-KV32C3	P2E-KV32C4
	48 Vdc	38	 P2E-KV32D0	P2E-KV32D1	P2E-KV32D2	P2E-KV32D3	P2E-KV32D4
	24 Vac 50Hz	38	 P2E-KV31C0	P2E-KV31C1	P2E-KV31C2	P2E-KV31C3	P2E-KV31C4
	48 Vac 50/60Hz	38	 P2E-KV34D0	P2E-KV34D1	P2E-KV34D2	P2E-KV34D3	P2E-KV34D4
	115 Vac 50Hz 120 Vac 60 Hz	38	 P2E-KV31F0	P2E-KV31F1	P2E-KV31F2	P2E-KV31F3	P2E-KV31F4
	230 Vac 50Hz 240 Vac 60 Hz	38	P2E-KV31J0	P2E-KV31J1	P2E-KV31J2	P2E-KV31J3	P2E-KV31J4

Cable plugs 15 mm - IP65

(8mm pin spacing)

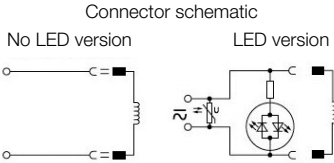
	Description	Electrical protection	Cable length	Weight (g)	Order code	
	Large headed screw	No protection	No cable	16	P8C-C	
	For inaccessible or recess position	LED + Protection 24 VDC	No cable	16	P8C-C26C	
	Standard screw	No protection	No cable	11	P8C-D	
			2 m cable	97	P8L-C2	
	Connector schematic No LED version LED version	LED + Protection 24 VDC	5 m cable	228	P8L-C5	
			No cable	11	P8C-D26C	
			LED + Protection 24 VDC/AC	2 m cable	97	P8L-C226C
			5 m cable	229	P8L-C526C	

Suppressor and LED indicators

For 8 mm solenoid pin spacing - For mounting between the solenoid valve and the cable plug

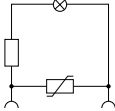
	Symbol	Description	Pneumatic connection	Weight (g)	Order code
		LED indicator	24 VAC/DC	3	P8V-CR26C
			115 VAC 50 Hz - 120 VAC 60 Hz	3	P8V-CR24F
			230 VAC 50 Hz - 240 VAC 60 Hz	3	P8V-CR24J

Spare mounting and assembly kits

	Description	Valve size	Port size	Weight (g)	Order code
	Kit for sealing the inlet/exhaust common gallery including : - 3 common blanking plugs - 2 drilled and threaded rods - 2 screws for extended tie rod	PVL-B		35	PVL-B1901
		PVL-C		65	PVL-C1901

Dimensions, PVL valve Series

All dimensions in mm unless otherwise stated

Stacking power valves 1/8" with pneumatic or electrical piloting - Monostable PVL-B1216••, PVL-B1236••

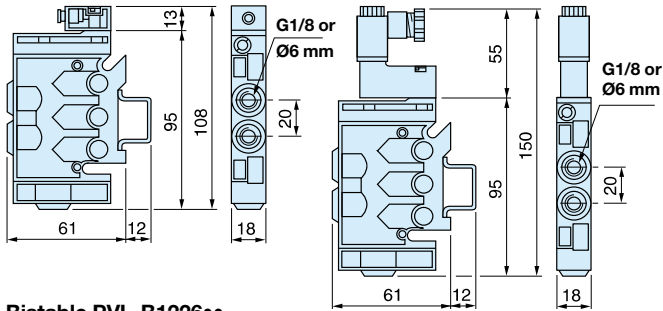

Stacking power valves 1/4" with pneumatic or electrical control - With 1 W solenoid actuator and suitable pneumatic connector - Monostable PVL-C1216••, PVL-C1236••

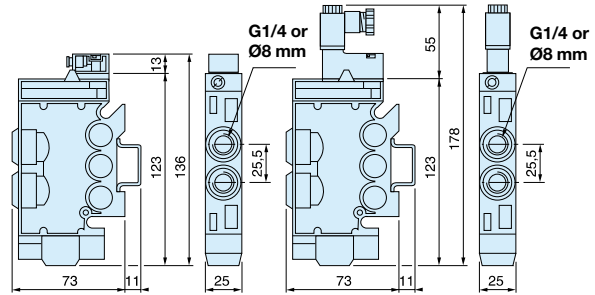

Bistable PVL-B1226••

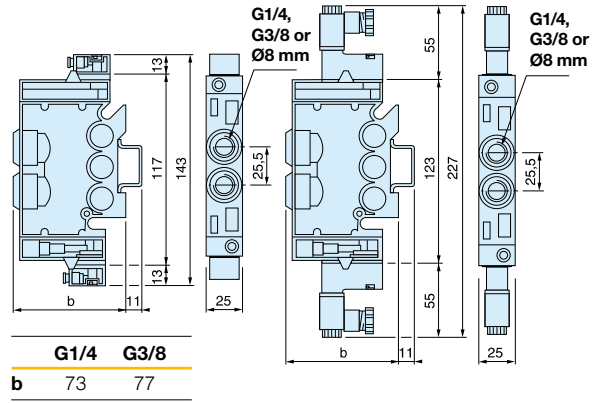
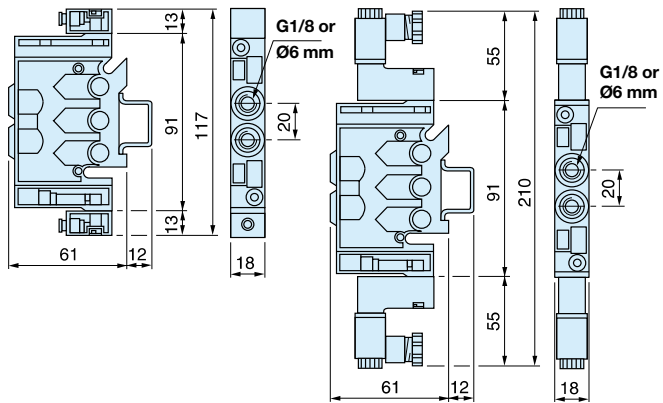

Head and tail sets

**Single air supply
PVL-B1719, PVL-C1713, mounting on DIN rail**

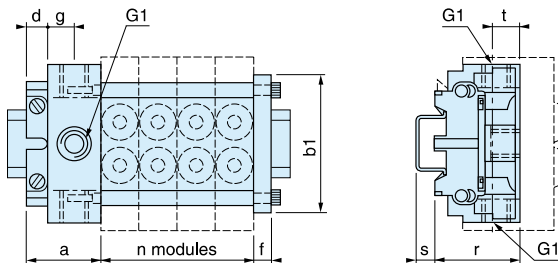

**Dual air supply
PVL-B1729, PVL-C1723, mounting on DIN rail**

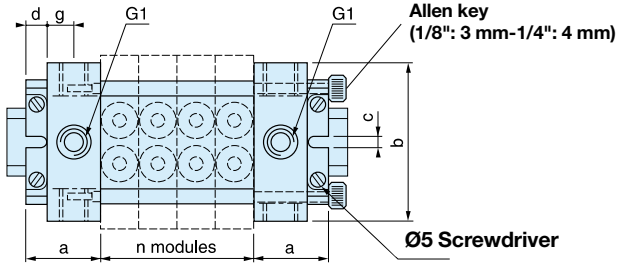

**Single air supply
PVL-B1818, PVL-C1819, "stack mounting"**

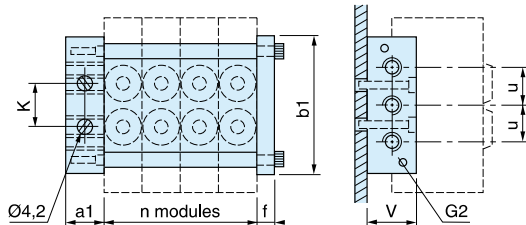

	a	a1	b	b1	c	d	f	g	G1	G2	k	r	s	t	u	v
1/8"	38	16	83	70	4,2	10	8	12	1/4"	1/8"	17,3	44	9	11	16	25
1/4"	38	20	108	100	4,2	10	8	12	3/8"	1/4"	63,5	55	9	13	20	30

**"Transfer / take-off" module, intermediate supply module
For combination of sizes 1/4" - 1/8" - PVU-LCB119**

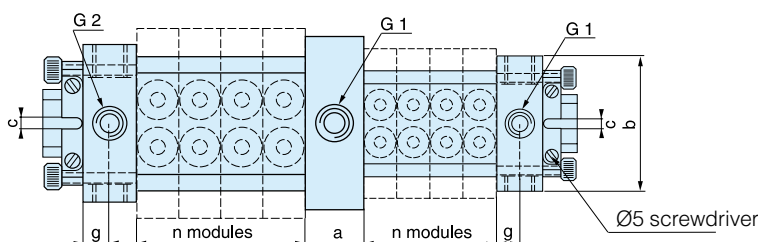

PVUL-BB118 - PVU-LCC119

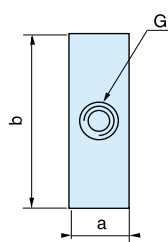

	a	b	G
1/8"	18	75	1/8
1/4"	25	100	1/4